

EVER stands

SMS Smart Media Solutions is proud to introduce its new range of floor stands, **EVER**. Building on years of innovation and experience, we have taken a step into the future with this sleek and versatile series.



Scandinavian Design
Manufactured in Europe



With a variety of sizes catering to a wide range of display needs and environments, EVER stands offers a selection that meets your specific requirements.

Meet the **EVER** family



EVER Stand 65

A slim and light weight stand, designed with true mobility and usage all over the workspace.

Max Load 60kg	Screen Size Max 65"	Max VESA 600x400	Available as Motorized YES
-------------------------	-------------------------------	----------------------------	--------------------------------------



EVER Stand 350

A beautiful and exceptionally versatile stand, suited for medium and large meeting rooms.

Max Load 100kg	Screen Size Max 86"	Max VESA 600x400	Available as Motorized YES
--------------------------	-------------------------------	----------------------------	--------------------------------------



EVER Stand 350 Air

A sleek and light weight stand with all essentials for a successful meeting experience.

Max Load 100kg	Screen Size Max 86"	Max VESA 600x400	Available as Motorized YES
--------------------------	-------------------------------	----------------------------	--------------------------------------



EVER Stand 620

A well-crafted stand, designed for large format presentations, clean installation and generous storage.

Max Load 120kg	Screen Size Max 98"	Max VESA 900x600	Available as Motorized YES
--------------------------	-------------------------------	----------------------------	--------------------------------------

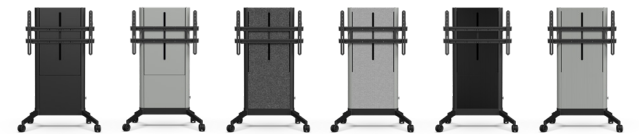

See display holder for dual displays and other accessories on next pages.

ACCESSORIES

Technology future-proof with extensive mounting possibilities for all your devices

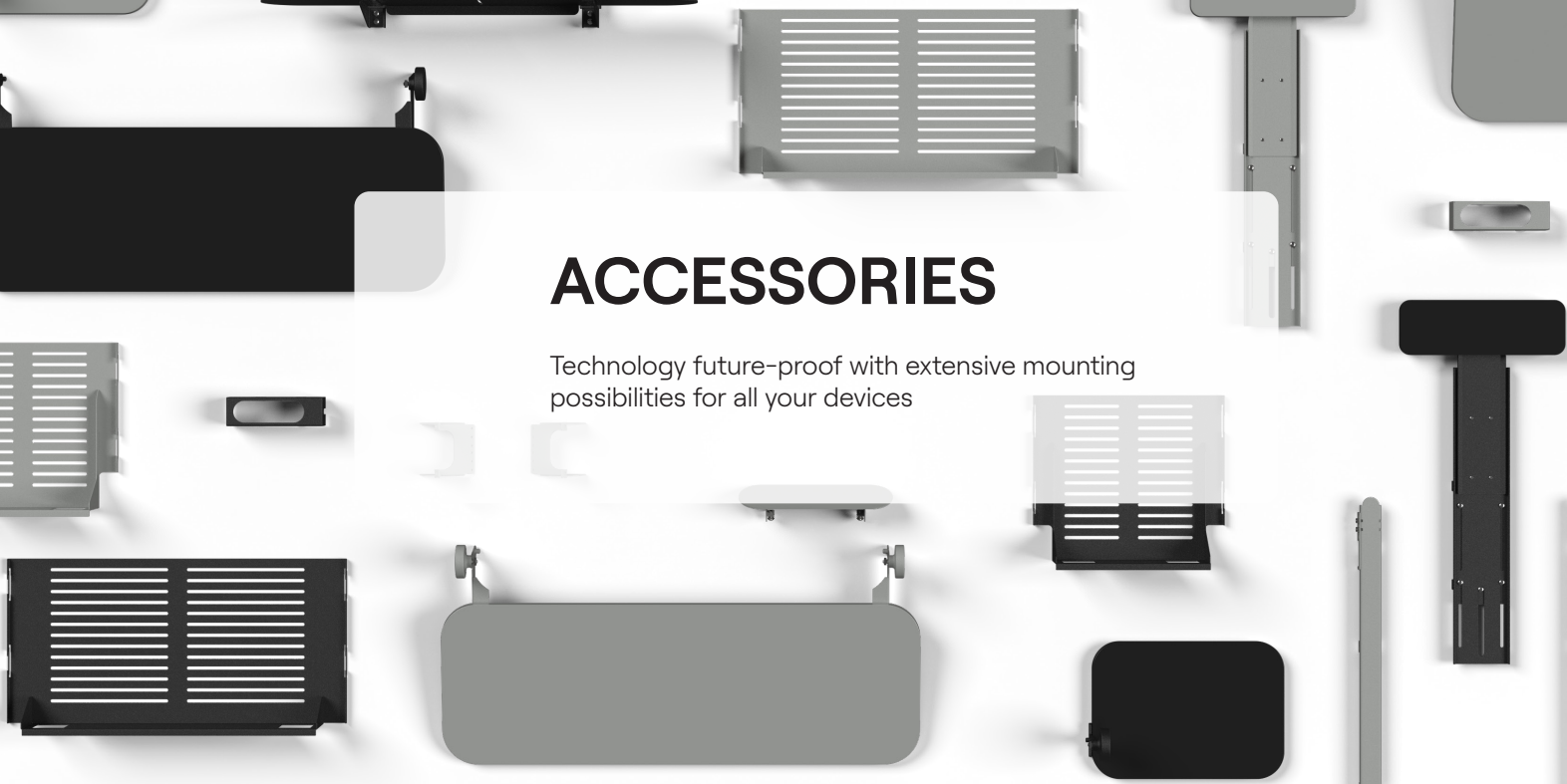

Universal shelves

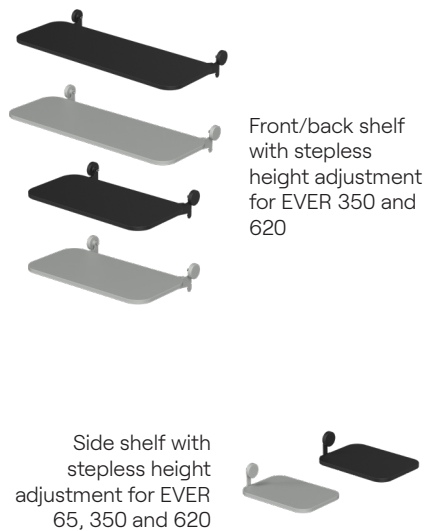

Device mounts/shelves

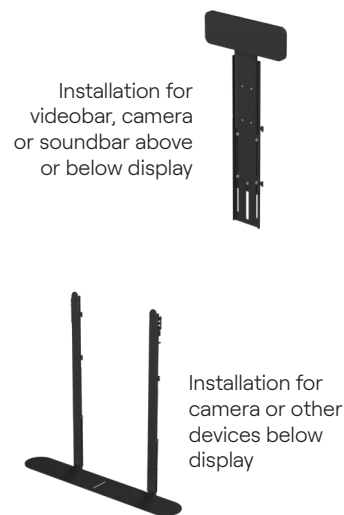

Installation

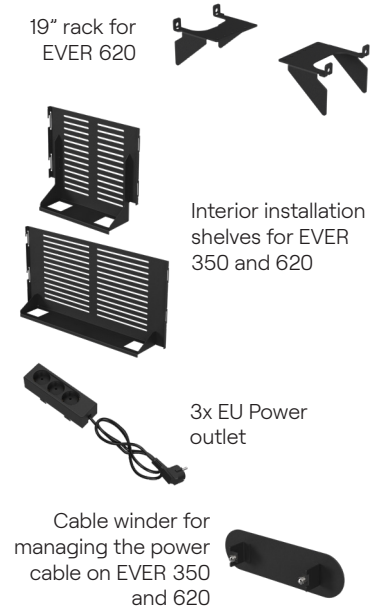

Display holders



















Future adapted design

EVER stands are designed for the needs of today, but prepared for whatever the future has to offer. With the modular approach EVER stands are extremely flexible products with a high level of adjustability and customization. With the possibility to upgrade your stand, the changing needs of tomorrow are easy to cover. The timeless design makes sure the stand blends well with the surrounding for years to come.

Accessory overview chart

These accessories are available in **Q3 2024**.

Visit our website for the latest updates and to stay informed about new features and upgrades.

														
		EVER350-620 Power strip EU	EVER Cable winder	EVER Camera mounting panel	EVER Under display shelf	EVER Side Shelf Dark/Light	EVER350 Installation shelf	EVER350 Shelf Dark/Light	EVER620 Shelf Dark/Light	EVER620 Installation shelf	EVER620 rack mount	MultiMount PRO 1500x600 A/DG (max 100kg)	Presence Mob VC 800x400 Holder (max 2x50kg)	Presence Mob VC XL 1000x600 Holder (max 2x50kg)
		16-110-1	16-108-1	16-105-1	16-104-1	16-101-1 / 16-101-9	16-106-1	16-102-1 / 16-102-9	16-103-1 / 16-103-9	16-107-1	16-109-1	03-027-6	05-022-6	05-023-6
	EVER 350 Air	X	X	X	X	(X) Placement only possible on the lower part of the stand	X	(X) Placement only possible on the lower part of the stand						
	EVER 350	X	X	X	X	X	X	X						
	EVER 620	X	X	X	X	X			X	X	X	X	X	X



Space clever

With EVER stands you can use your workspace more cleverly and boost team **collaboration**. With the high **mobility** you can easily move them around and meet anywhere, heavily reducing the need for fixed installation. Good for both wallet and planet.

Flexible and adjustable

With a focus on flexibility, EVER Stands feature adjustable components and modular design, allowing you to tailor the stand to your changing requirements.

Easy to upgrade

EVER Stands are designed to facilitate seamless upgrades. As technology advances or your needs evolve, you can easily enhance your stand's capabilities without the need for a completely new stand.

Timeless and future proof

Embracing a timeless aesthetic, EVER Stands effortlessly blend into any environment, both today and for years to come.



Ergonomic work

Our mounting systems allows you to mount accessories and handles in any height.

Fast and Flexible

With our QuickAdjust system height can be adjusted in no time. No tools required.

Adjustable wheelbase

With our modular and innovative design approach adjustability is built into the design.

Upgrade to a new look

Our clever cover system makes it quick, easy, and affordable to upgrade the look of your stand.

Turn fixed into motorized

Make your fixed stand more useable by adding a motor kit.

Change the size of your stand

It's possible to change the width of your stand. Keep the side section and only replace the middle section.

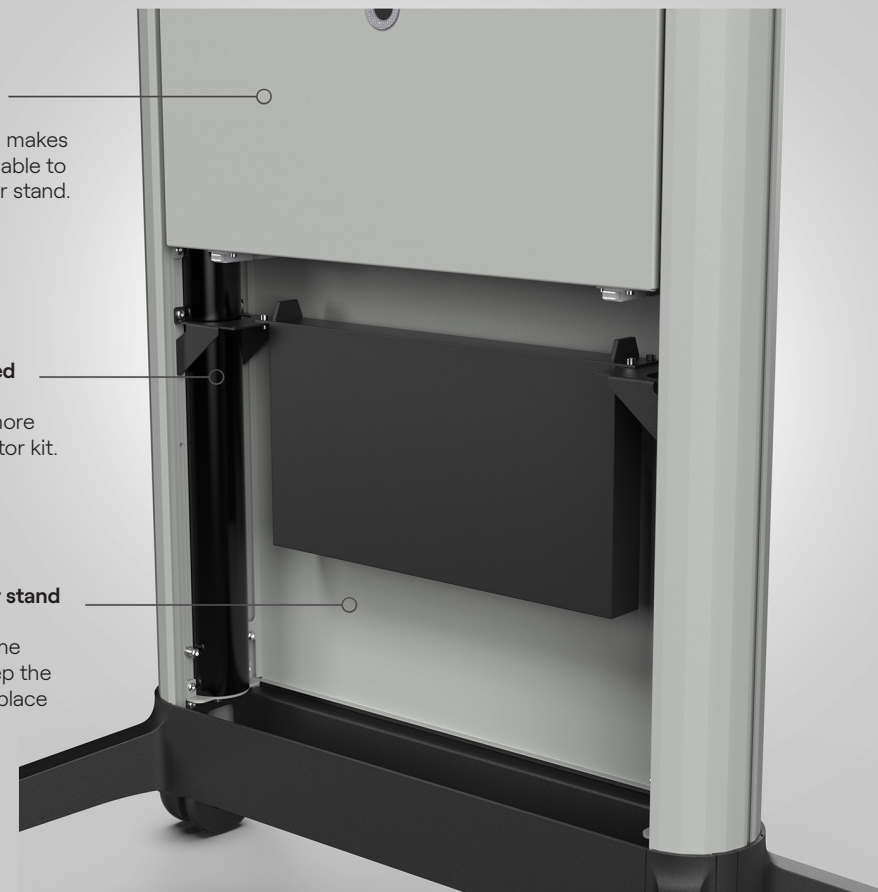

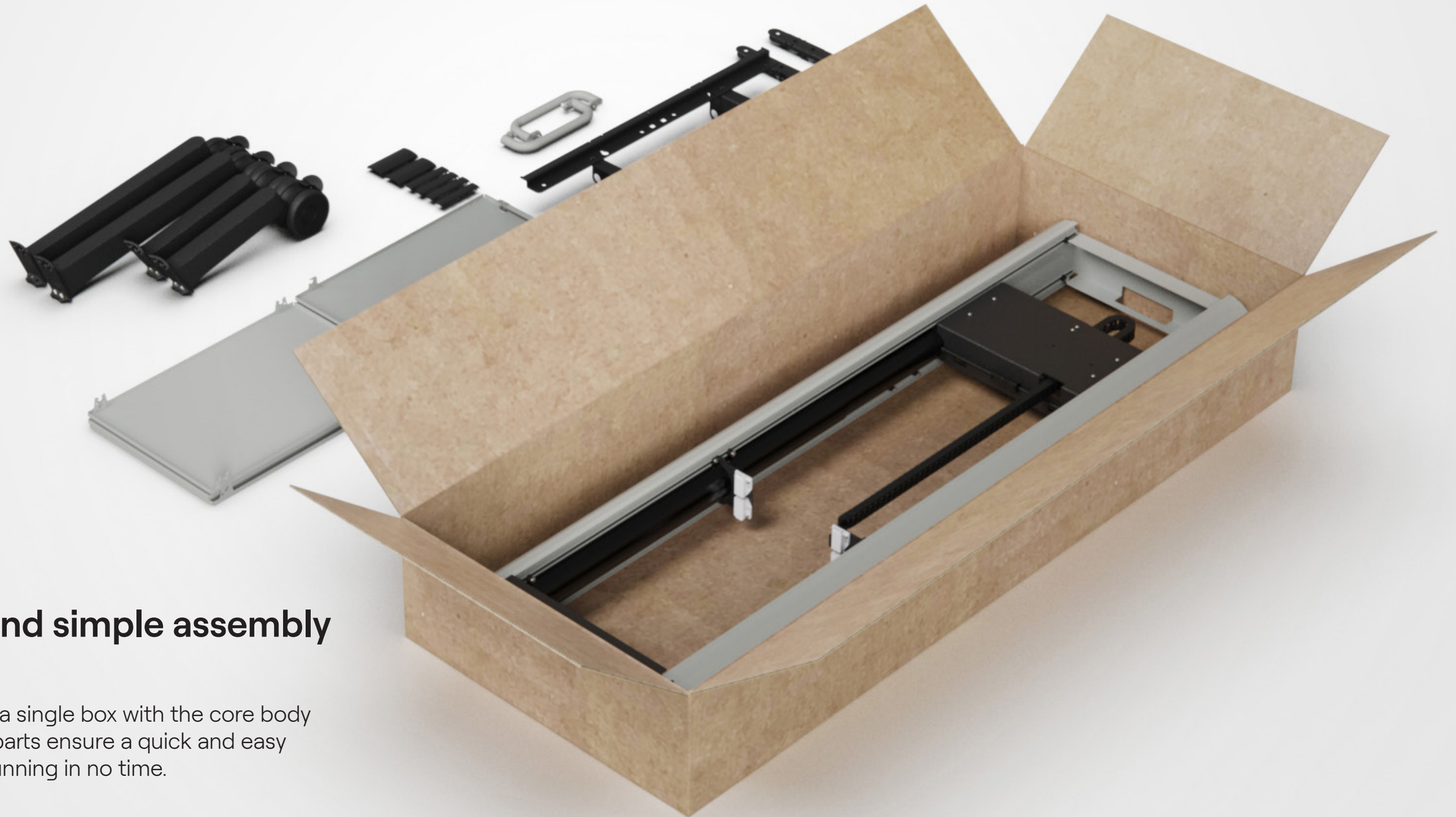

Easy shipping and simple assembly

The EVER stands arrive in a single box with the core body pre-assembled. Minimal parts ensure a quick and easy setup - you'll be up and running in no time.

Smart inside and inviting outside

The clever inside of the stand hides the tech away and makes installation easy and super clean. This provides a minimalistic exterior that, together with the uniform design language over the entire range, creates an inviting and easy-to-understand product where all functions are clear and work the same way. Knowing one you know them all.

On the picture you can see the Interior installation shelf accessory. With this you can streamline the device installation process, making it both faster and more professional.



What style are you?

Two base colours

EVER stands come in two colours, Midnight Grey and Light Grey.

To complement them and provide more design options, we offer three different cover options:

Soft covers - made of acoustic recycled PET felt.

Clean covers - made of powder coated aluminum.

Edge covers - made of painted MDF with a stripe pattern.

Each of them with a unique look and clear benefits.

Clean covers

With a unique fastening technique, EVER's aluminium covers are super quick to open and close. No screws or tools needed. The smooth aluminium covers have the exact same colour and surface finish as the rest of the stand, providing a unicolor and minimalistic look.

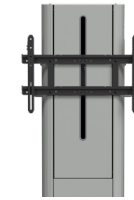

Soft covers

With our acoustic covers you get excellent soundabsorbing properties and contributes to a quieter and more productive work environment. Furthermore, PET felt is a sustainable choice, made from recycled plastic bottles. And on top of all it is a very good choice when placing WiFi devices inside the stand.

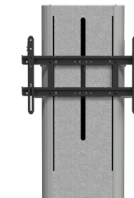

Edge covers

The smooth and fine finish of our crafted MDF covers provides a distinct furniture feel that adds a touch of sophistication to the office environment. Compared to other commonly used furniture materials, like high quality plywood, MDF is a more affordable choice and maintains its shape over time.

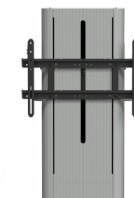

Customize to fit your office

With our EVER Custom offer you
can really stand out from the crowd.



SMS Smart Media Solutions is a leading provider of innovative AV solutions, empowering businesses and organizations to excel in their communication and collaboration efforts.

Through a commitment to exceptional quality, user-friendly Scandinavian designs, and sustainable practices, SMS Smart Media Solutions is shaping the future of AV mounting technology.

Stands, Mounts and Casings
Made in Europe.

www.smartmediasolutions.com

